

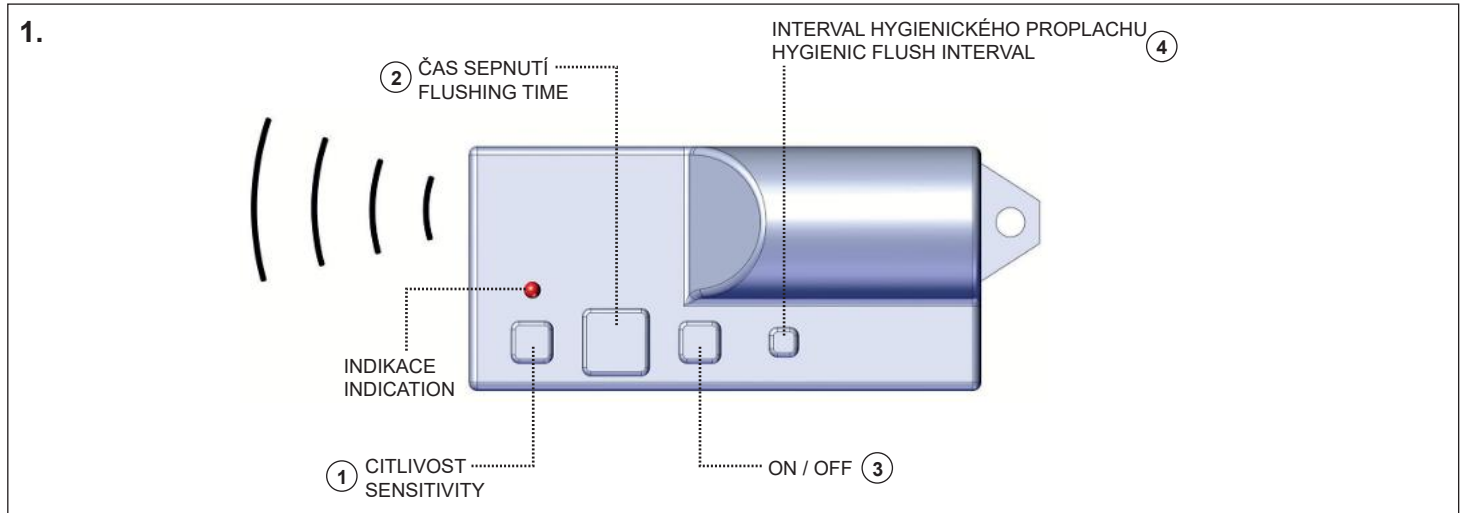

Dálkové ovládání pro nastavení parametrů infračervených čidel
Universal remote control for setting of infra-red sensors

CS	Návod na použití	RU	Инструкция по эксплуатации	RO	Instrucțiuni de utilizare	NL	Gebruiksaanwijzing
SK	Návod na použitie	DE	Gebrauchsanleitung	ES	Instrucciones de uso	LT	Naudojimosi instrukcija
EN	Instructions for use	PL	Instrukcja użytkowania	FR	Mode d'emploi		



CS	Princip funkce	RU	Принцип функции	RO	Principiu de funcționare	NL	De basis van de werking
SK	Princip funkcie	DE	Grundsätzliche Funktionen	ES	Principio de función	LT	Veikimo principas
EN	Principle of function	PL	Główne funkcje	FR	Principe de fonctionnement		

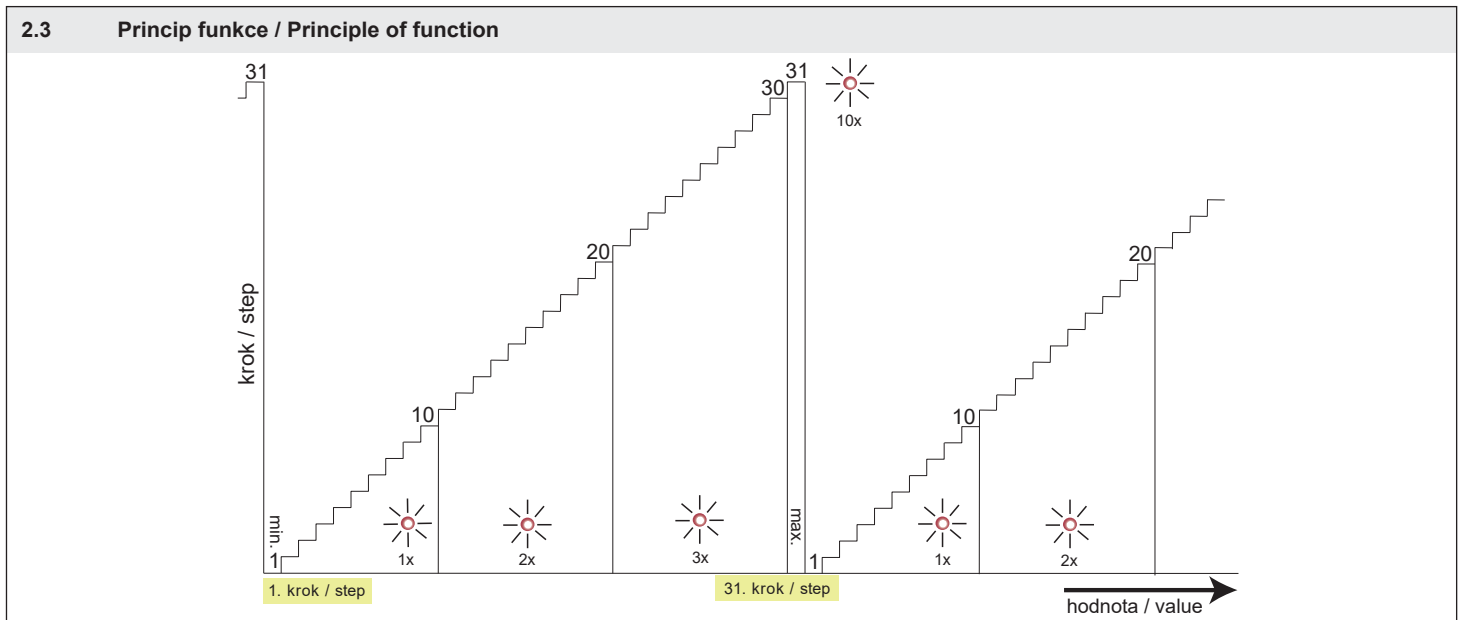
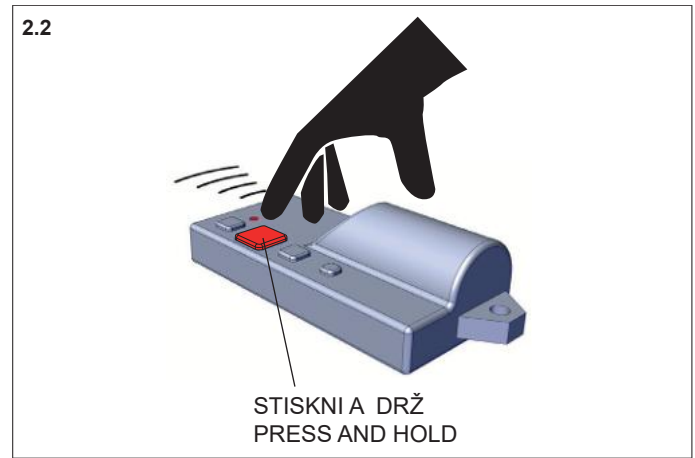
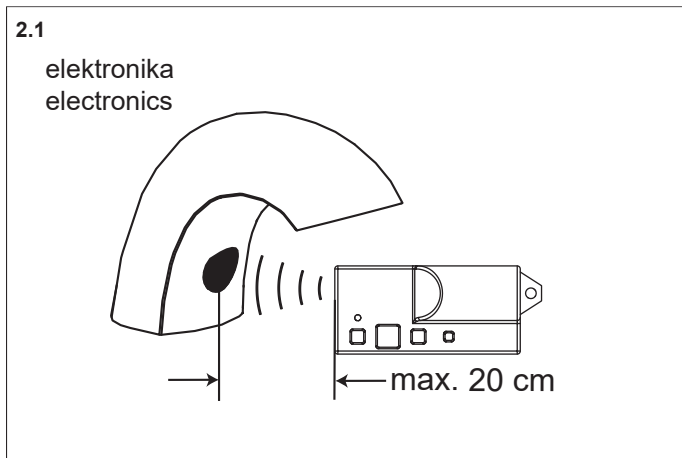

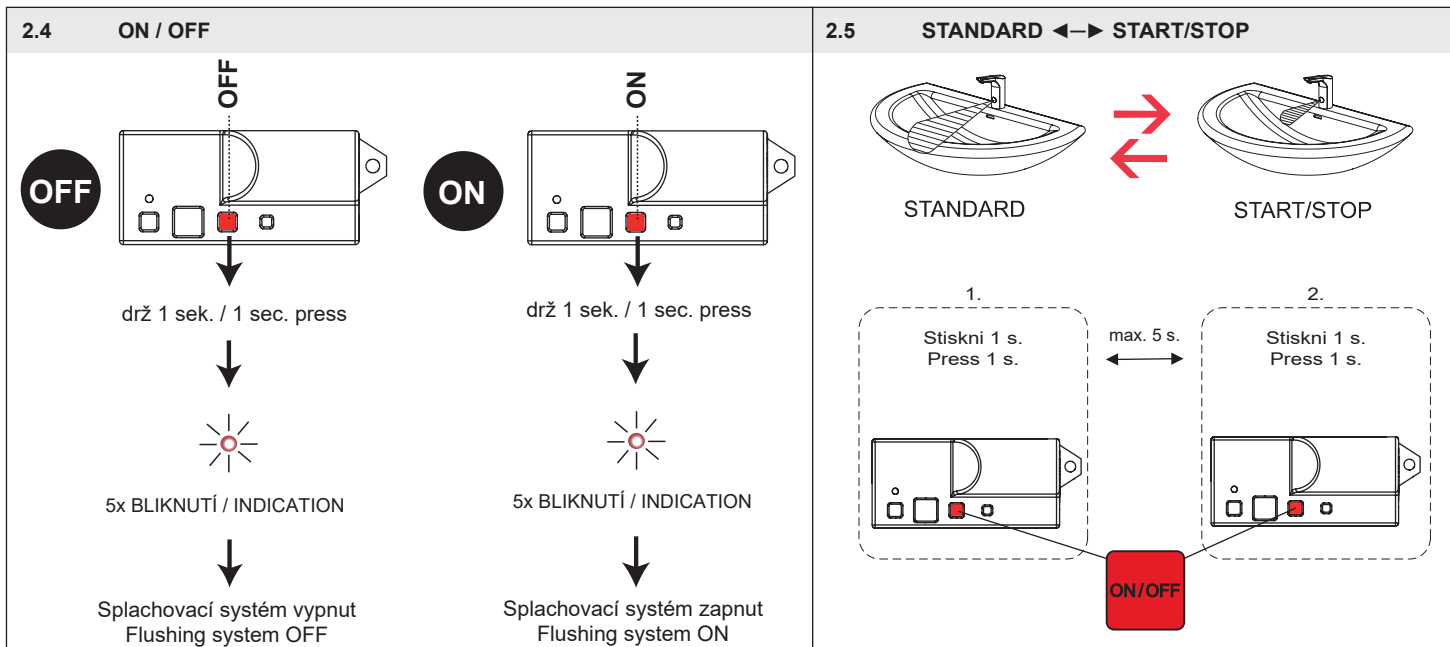

(CS) Reset do továrního nastavení (SK) Reset do továrenského nastavenia (EN) Return to factory adjustment	(RU) Возврат в заводскую настройку (DE) Auf Werkseinstellung zurück setzen (PL) Reset do podstawowych nastawów	(RO) Revenire la setările din producție (ES) Restablecimiento al ajuste de fábrica (FR) Retour au réglage usiné	(NL) Terug naar fabrieksinstellingen (LT) Atsatyti gamyklinius nustatymus
---	--	---	--

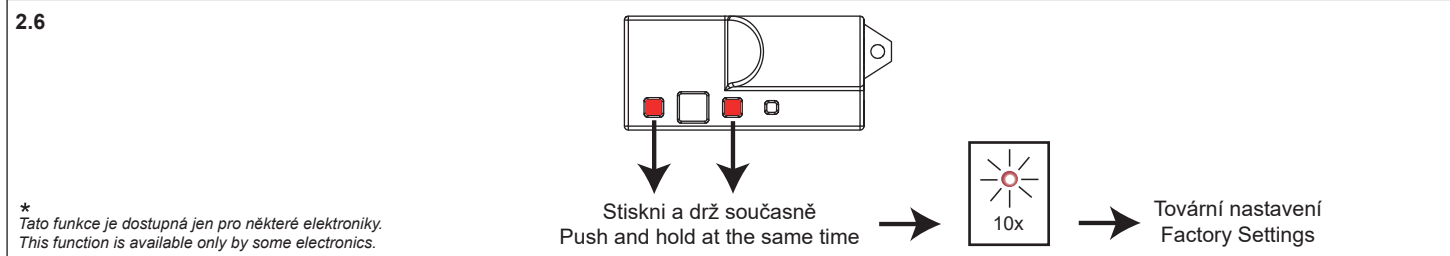



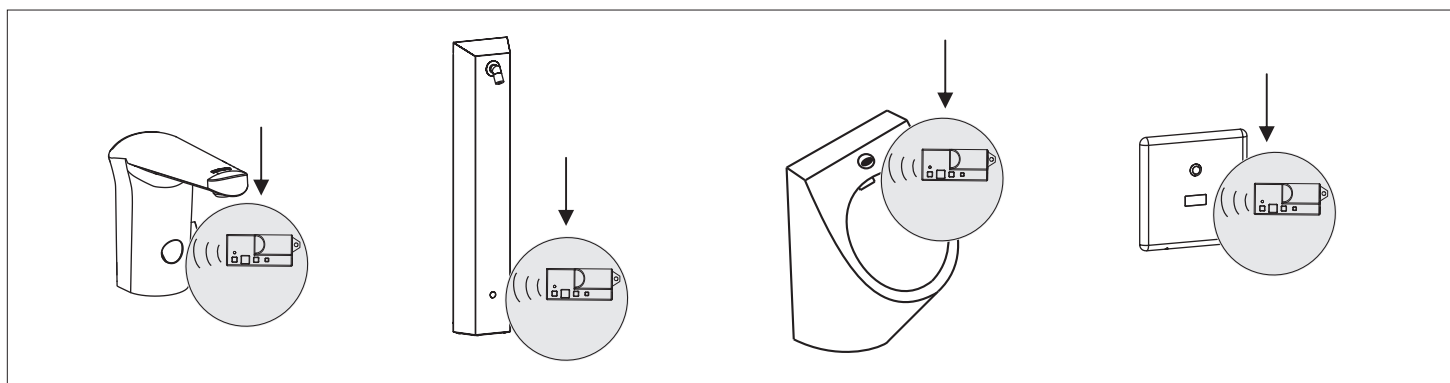





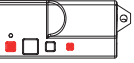

3. (CS) Přehled typů (SK) Prehľad typov (EN) Types overview	(RU) Перечень типов (DE) Typen Übersicht (PL) Przegląd typów	(RO) Prezentarea tipurilor (ES) Resumen de los tipos de los productos (FR) Vue d'ensemble	(NL) Type overzicht (LT) Tipų apžvalga
--	--	---	---

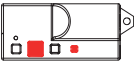

4. (CS) Nastavení (SK) Nastavenie (EN) Adjustment	(RU) Настройка (DE) Einstellung (PL) Regulacja	(RO) Reglaj (ES) Ajuste (FR) Réglage	(NL) Afstelling (LT) Reguliavimas
--	--	--	--------------------------------------

tlačítko button	název name		umyvadlo washbasin	sprcha shower	pisoár urinal	WC toilet
1. 	citlivost sensitivity	počet kroků number of steps	31	31	31	31
		rozsah range	0,1 - 0,3 m	0,3 - 0,7 m	0,3 - 0,7 m	0,3 - 0,7 m
		krok step				
		tovární nastavení factory settings				
2. 	čas sepnutí flushing time zpoždění vypnutí ventilu valve deactivation delay (sprcha / shower)	počet kroků number of steps	31	31	31	31
		rozsah range	0,25 s. - 7,75 s.	0,25 s. - 7,75 s.	0,5 s. - 15,5 s.	0,5 s. - 15,5 s.
		krok step	0,25 s.	0,25 s.	0,5 s.	0,5 s.
		tovární nastavení factory settings	0,25 s.	3 s.	3 s.	5 s.

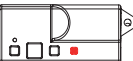
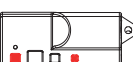
 <p>(1.)</p>	<p>citlivost sensitivity START / STOP</p>	počet kroků number of steps	4	4			
		rozsah range	4 / 8 / 12 / 16	4 / 8 / 12 / 16			
		krok step	4	4			
		tovární nastavení factory settings	3. krok / step	3. krok / step			
 <p>(2.)</p>	<p>čas sepnutí flushing time START / STOP</p>	počet kroků number of steps	31	31			
		rozsah range	10 s. - 310 s.	10 s. - 310 s.			
		krok step	10 s.	10 s.			
		tovární nastavení factory settings	310 s.	310 s.			
 <p>4.</p>	<p>interval hygienického proplachu hygienic flush interval</p>	počet kroků number of steps	7				
		rozsah range	OFF / 6 h. / 8 h. / 12 h. / 24 h. / 48 h. / 72 h. / 7 dní/days				
		krok step					
		tovární nastavení factory settings	OFF		24 h.		
 <p>1.+4.</p>	<p>délka hygienického proplachu hygienic flush duration</p>	počet kroků number of steps	31				
		rozsah range	5 s. - 1200 s.				
		č. kroku/čas/krok step nr./time/step	1 - 6 7 - 12 13 - 21 22 - 30 31	5 s. - 30 s. 40 s. - 90 s. 120 s. - 360 s. 420 s. - 900 s. 1200 s.	5 s. 10 s. 30 s. 60 s.		
		tovární nastavení factory settings	5 s.				
 <p>2.+3.</p>	<p>předplach / doplach flush before use flush after use</p>	počet kroků number of steps		4			
		krok step		1. OFF 2. předplach ON 3. doplach ON 4. předplach ON doplach ON			
		tovární nastavení factory settings	OFF				
 <p>2.+3.</p>	<p>časová pojistka time-delay fuse</p>	počet kroků number of steps	31				
		rozsah range	10 - 310 s.				
		krok step	10 s.				
		tovární nastavení factory settings	300 s.				
 <p>2.+4.</p>	<p>zpoždění aktivace sprchy shower activation delay</p>	počet kroků number of steps		31			
		rozsah range		0 - 15 s.			
		krok step		0,5 s.			
		tovární nastavení factory settings		2 s.			

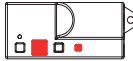
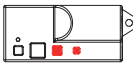
tlačítko button	název name		SLU 45MD / 46MD / 45Mx	dávkače mýdla / dezinfekce soap / disinfection dispenser
1. 	citlivost sensitivity	počet kroků number of steps	31	31
		rozsah range	0,1 - 0,3 m	0,1 - 0,3 m
		krok step		
		tovární nastavení factory settings	10. krok / step	
2. 	čas sepnutí flushing time	počet kroků number of steps	31	
		rozsah range	0,25 s. - 7,75 s.	
		krok step	0,25 s.	
		tovární nastavení factory settings	0,25 s.	
(1.) 	citlivost sensitivity START / STOP	počet kroků number of steps	4	
		rozsah range	4 / 8 / 12 / 16	
		krok step	4	
		tovární nastavení factory settings	3. krok / step	
(2.) 	čas sepnutí flushing time START / STOP	počet kroků number of steps	31	
		rozsah range	10 s. - 310 s.	
		krok step	10 s.	
		tovární nastavení factory settings	310 s.	
4. 	interval hygienického proplachu hygienic flush interval	počet kroků number of steps	7	7
		rozsah range	OFF / 6 h. / 8 h. / 12 h. / 24 h. / 48 h. / 72 h. / 7 dní/days	OFF / 6 h. / 8 h. / 12 h. / 24 h. / 48 h. / 72 h. / 7 dní/days
		krok step		
		tovární nastavení factory settings	OFF	24 h.
1.+4. 	délka hygienického proplachu hygienic flush duration	počet kroků number of steps	31	31
		rozsah range	5 s. - 1200 s.	1 s. - 80 s.
		č. kroku/čas/krok step nr./time/step	1 - 6 5 s. - 30 s. 5 s. 7 - 12 40 s. - 90 s. 10 s. 13 - 21 120 s. - 360 s. 30 s. 22 - 30 420 s. - 900 s. 60 s. 31 1200 s.	1 - 10 1 s. - 10 s. 1 s. 11 - 20 12 s. - 30 s. 2 s. 21 - 30 35 s. - 80 s. 5 s.
		tovární nastavení factory settings	5 s.	1 s.
1.+2. 	předplach flush before use	počet kroků number of steps	2	2
		rozsah range	ON / OFF	ON / OFF
		krok step		
		tovární nastavení factory settings	OFF	OFF
2.+3. 	délka dávky mýdla / dezinfekce amount of soap / disinfection dose (length of dosing cycle)	počet kroků number of steps	10	10
		rozsah range	1,3 s. - 13 s.	0,5 s. - 5 s.
		krok step	1,3 s.	0,5 s.
		tovární nastavení factory settings	2,6 s.	mýdlo / soap 2,5 s. dezinfekce / disinfection 1,5 s.
2.+4. 	prodleva před sepnutím ventilu soaping time of hands before running water	počet kroků number of steps	31	
		rozsah range	0,5 s. - 15,5 s.	
		krok step	0,5 s.	
		tovární nastavení factory settings	2 s.	
3.+4. 	tlačítko doplnění mýdla soap replenish ON/OFF	počet kroků number of steps	2	
		rozsah range	ON / OFF jinak běží 300 s. / the whole cycle without stop takes 300 s.	
		krok step		
		tovární nastavení factory settings		

tláčítko button	název name		SLZN 83E/EV/EX / 91E/91EX / 84A/F	SLZN 59E / 84J
1.+2. 	zpětný chod reversed motion	počet kroků number of steps	2	2
		rozsah range	ON / OFF	ON / OFF
		krok step		
		tovární nastavení factory settings	ON	OFF

5. CS Sanitární spláchnutí RU Санитарный смыв RO Spălare de igienizare NL Hygiënische spoeling
SK Sanitárne spláchnutie DE Hygienespülung ES Limpieza sanitaria LT Sanitarinis vandens nuleidimas
EN Sanitary flush PL Sanitarne splukanie FR Chasse d'eau

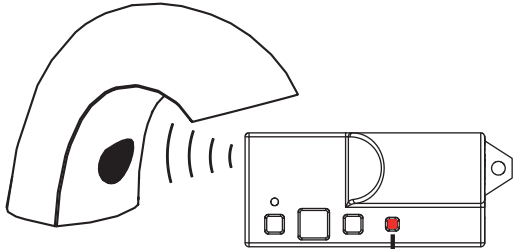

stiskni a drž / press and hold →

KROK STEP	BLIKNUTÍ INDICATION	HODINY HOURS
		
1	1x	OFF
2	1x	6:00
3	1x	8:00
4	1x	12:00
5	2x	24:00
6	2x	48:00
7	2x	72:00
8	10x	168:00

6. CS Předplach / Doplach RO Spălare înainte de utilizare / Spălare după utilizare
SK Predplach / Doplach ES Enjuague antes del uso / Enjuague después del uso
EN Flush before use / Flush after use FR Rinçage à rapprochement / Rinçage à éloignement
RU Смыть перед использованием / Смыть после использования NL Voorspoeling / Spoeling na gebruik
DE spült vor Gebrauch / spült nach Gebrauch LT Nuleidimas prieš naudojantis / Nuleidimas po naudojimosi
PL Przepłukanie / Do płukanie

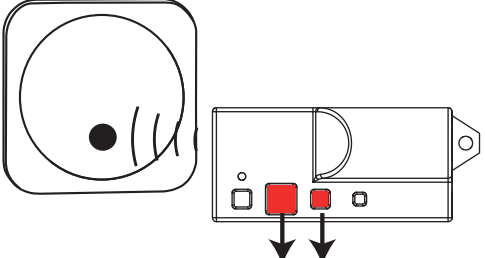

stiskni a drž současně / push and hold at the same time →

pro pisoárové splachovače
for urinal flushing

KROK STEP	BLIKNUTÍ INDICATION	FUNKCE FUNCTION	
		PŘEDPLACH FLUSH BEFORE USE	DOPLACH FLUSH AFTER USE
			
1	1x	OFF	OFF
2	2x	ON	OFF
3	3x	OFF	ON
4	10x	ON	ON

7.	CS ECO mód	RU ЭКО-режим	RO Mod ECO	NL ECO-modus
	SK ECO mód	DE ECO-Modus	ES Modo ECO	LT ECO režims
	EN ECO mode	PL Tryb ECO	FR Mode ÉCO	

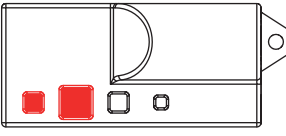
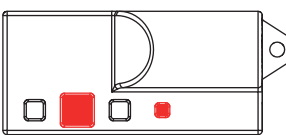
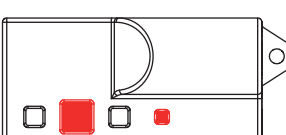
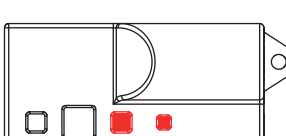
tlačítko button	název funkce function name		
1.+2. 	vypnutí / přepínání OFF / mode change	počet kroků number of steps	3
		rozsah range	mód 1 / 2 / OFF mode 1 / 2 / OFF
		krok step	—
		tovární nastavení factory settings	OFF
2.+4. 	doba mezi spláchnutím time between flushes	počet kroků number of steps	31
		rozsah range	5 - 1200 s.
		krok step	viz tabulka č. 3 see table no. 3
		tovární nastavení factory settings	300 s.
2.+4. 	délka krátkého spláchnutí duration of short flush	počet kroků number of steps	31
		rozsah range	0,5 - 15, 5 s.
		krok step	0,5 s.
		tovární nastavení factory settings	1 s.
3.+4. 	počet použití number of uses	počet kroků number of steps	30
		rozsah range	1 - 30
		krok step	1
		tovární nastavení factory settings	10

(tabulka č. 3 / table No. 3)

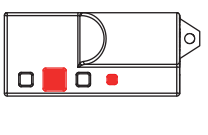
tlačítko button	název funkce function name	počet kroků number of steps	rozsah range	č. kroku step nr.	čas time	tovární nastavení factory settings
2.+4. 	doba mezi spláchnutím time between flushes	31	5 - 1200 s.	1	5 s.	300 s.
				2	10 s.	
				3	15 s.	
				4	20 s.	
				5	25 s.	
				6	30 s.	
				7	40 s.	
				8	50 s.	
				9	60 s.	
				10	70 s.	
				11	80 s.	
				12	90 s.	
				13	120 s.	
				14	150 s.	
				15	180 s.	
				16	210 s.	
				17	240 s.	
				18	270 s.	
				19	300 s.	
				20	330 s.	
				21	360 s.	
				22	420 s.	
				23	480 s.	
				24	540 s.	
				25	600 s.	
				26	660 s.	
				27	720 s.	
				28	780 s.	
				29	840 s.	
				30	900 s.	
				31	1200 s.	